

Quick Installation Guide

R Series Inverter

1. Packaging List

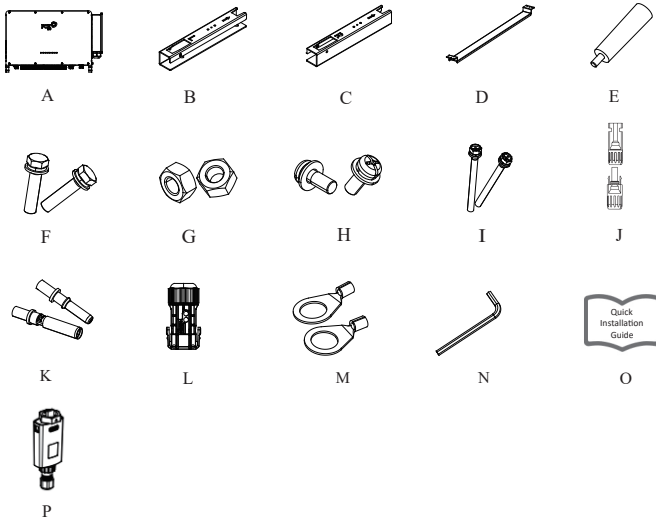

Object	Quantity	Description	Object	Quantity	Description
A	1	Inverter	I	4	M4*10 Screw
B	1	Left Hanging Plate	J	36	DC Connector (Positive*18, Negative*18)
C	1	Right Hanging Plate	K	36	DC Pin Plug (Positive*18, Negative*18)
D	1	Hanging Plate Connection Bar	L	1	Communication Connector
E	4	Screw-in Type Handle	M	2	Ground Terminal
F	4	M10*45 Bolt Assembly	N	1	5mm Internal Hexagon Wrench
G	4	M10 Hexagon Nut	O	1	Quick Installation Guide
H	2	M6*50 Bolt Assembly	P	1	Smart WiLANII

2. Inverter Installation

Please make sure the inverter will be installed with a proper distance as shown below.

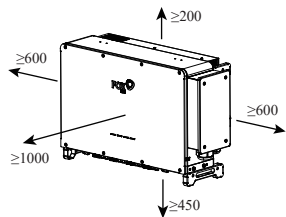

Position	Min Size
Left	600 mm
Right	600 mm
Top	200 mm
Bottom	450 mm
Front	1000 mm

Step 1: Hanging Plate Assembly

Install the Inverter on a bracket or wall by means of the hanging plate. The hanging plate assembly diagram and the size of the assembled hanging plate are shown as below:

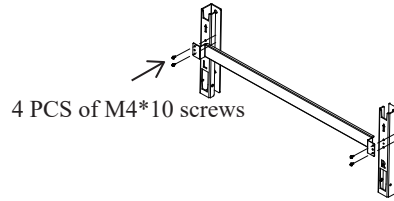

Hanging Plate Assembly Diagram

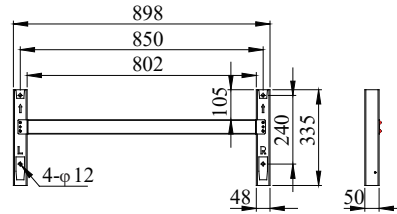

The Size of Hanging Plate

Step 2: Bracket-mounted Installation or Wall-mounted Installation

Mode 1: Bracket-mounted Installation

1. Place the assembled hanging plate on a PV bracket, adjust the angle with a level, mark drilling positions, and drill holes with an electric drill (with a φ12 drill bit).

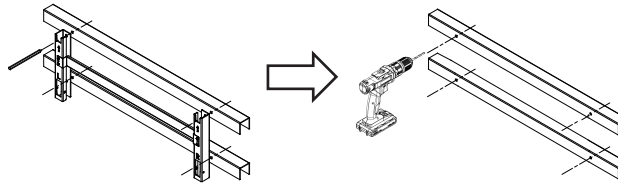

2. Fix the hanging plate with bolts.

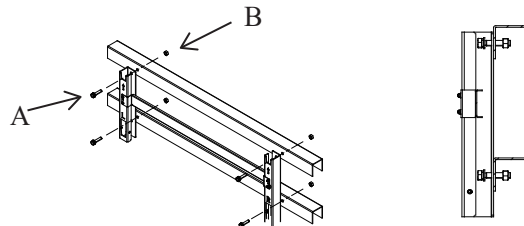

A: 4 PCS of M10*45 hexagon bolts
B: 4 PCS of hexagon nuts

Mode 2: Wall-mounted Installation

1. Place the assembled hanging plate at the installation site, adjust the angle with a level, and mark drilling positions.

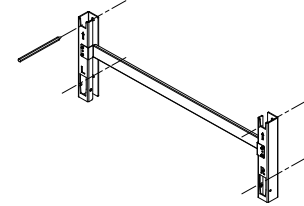

2. Drill holes with a hammer drill (with a φ12 drill bit), clear holes, insert 4 PCS of expansion bolts (by client, M10*95 is recommended) into holes, and fix them with a rubber hammer.

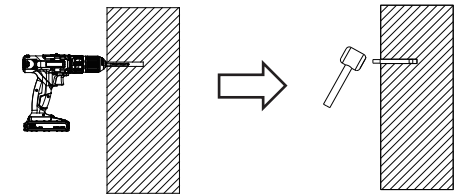

3. Fix the hanging plate with expansion bolts.

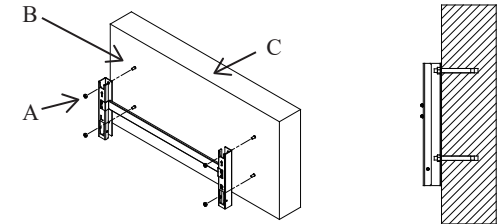

A: 4 PCS of M10 hexagon nuts B: 4 PCS of expansion bolts (M10) C: Wall

Step 3: Inverter Installation

1. Lift the inverter from the package box with 4 PCS of screw-in type handles.

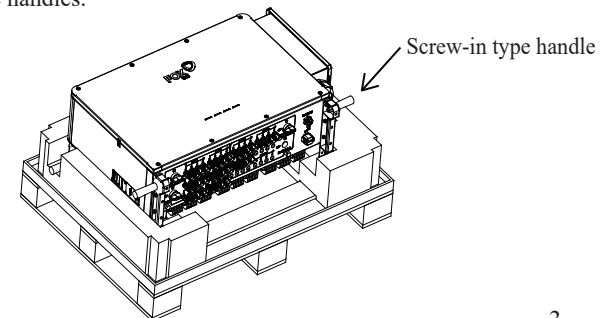

2. Install the inverter on the hanging plate, and ensure that lugs of the inverter are properly matched with slots of the hanging plate.

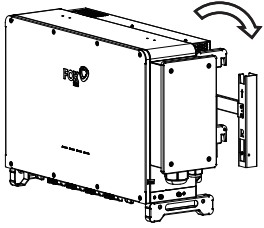

3. Secure the inverter with bolts.

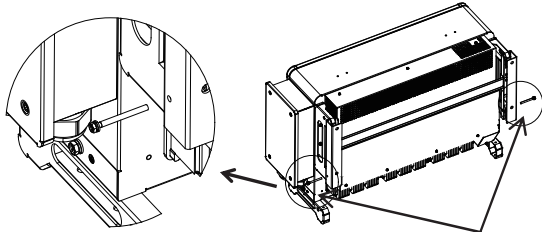

2 PCS of M6*50 bolts

3. Electrical Connection

Step 1: Secondary Ground Connection

Lock crimped ground cables to ground holes with screw locks on the inverter case, and paint the ground screws and ground terminals to improve anti-corrosion characteristics.

The conductor sectional area of each ground cable is 0.5~10 mm² (4~6 mm² is recommended).

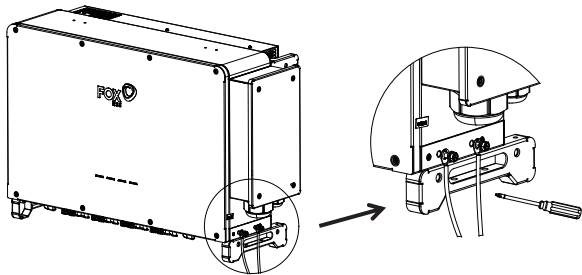

Step 2: AC Side Connection

Recommended Specification:

Cable Type	Outer Diameter (mm)	Conductor Sectional Area (mm ²)
AC Cable	38~56	L1,L2,L3,(N) cables: 70~240 PE: S/2 (S is a sectional area of AC phase cable)

1. Open the AC side wiring box with a 5mm internal hexagon wrench. Open the breaker and prevent its accidental reclose.

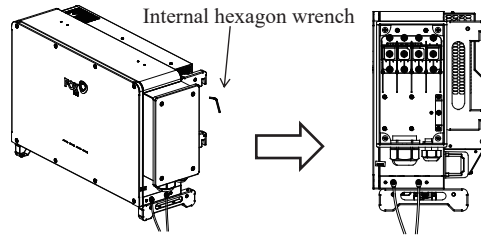

2. Unscrew the lock nut of the waterproof connector and take out multilayer sealing rings. Select the sealing ring based on the cable outer diameter. Route the cable through the lock nut and sealing ring.

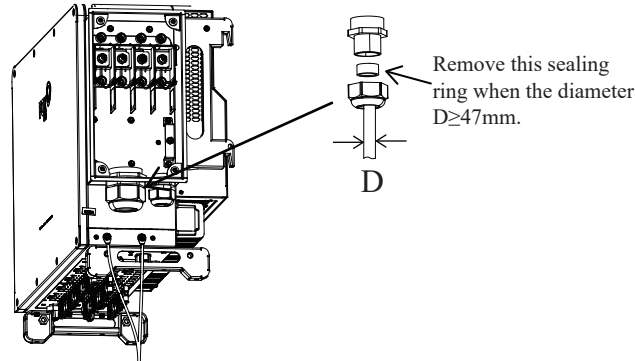

3. Peel off the protective layer and insulation layer of a certain length and crimp the cold-pressed terminals as shown below:

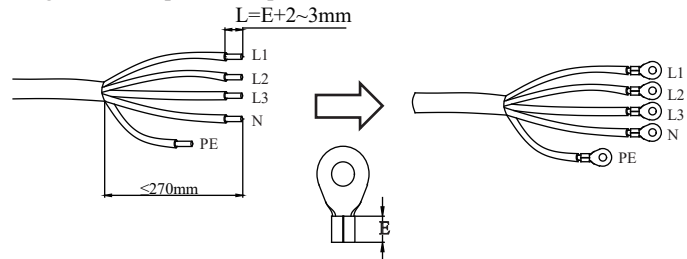

4. Secure cables to the corresponding terminals with a hexagon socket wrench and a cross screwdriver, and tighten the waterproof cable heads.

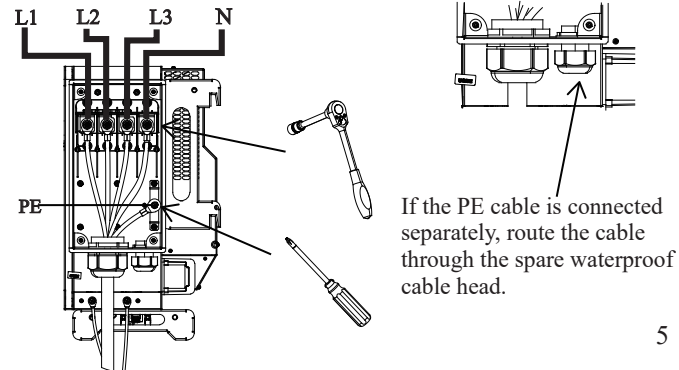

Step 3: DC Side Connection

1. Turn off the DC switch.
2. It is recommended that the DC cable dedicated to photovoltaics (2.5~4 mm²) be used to connect the PV module.
3. Trim about 6mm of insulation from the cable end.

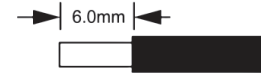

4. Separate the DC connector as below.

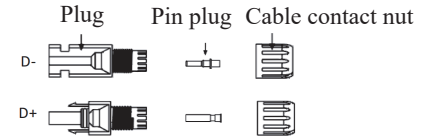

5. Insert multiple cables connected to the PV module into the pin plug and ensure all strands are captured in the pin plug.

6. Crimp the pin plug with a crimping plier.

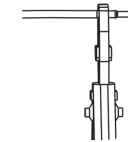

7. Route the crimped cable through the nut into the plug. When you hear a "click", the pin plug is properly clamped in the plug.

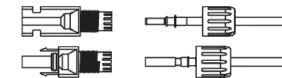

4. Startup Procedure

- After checking all connections are proper, turn on the external DC/AC breakers.
- Turn the DC switch to "ON".
- The inverter will start automatically when PV panels generate enough energy, and the LED will turn blue.

After-sales Service Mail: service@fox-ess.com

Scan the QR for User Manual



V1.2
10-203-00289-02